

Varenummer: 20092167

Beskrivelse: E+G Bøjlegreb GN 565.4-26-192-A-SW

Mål

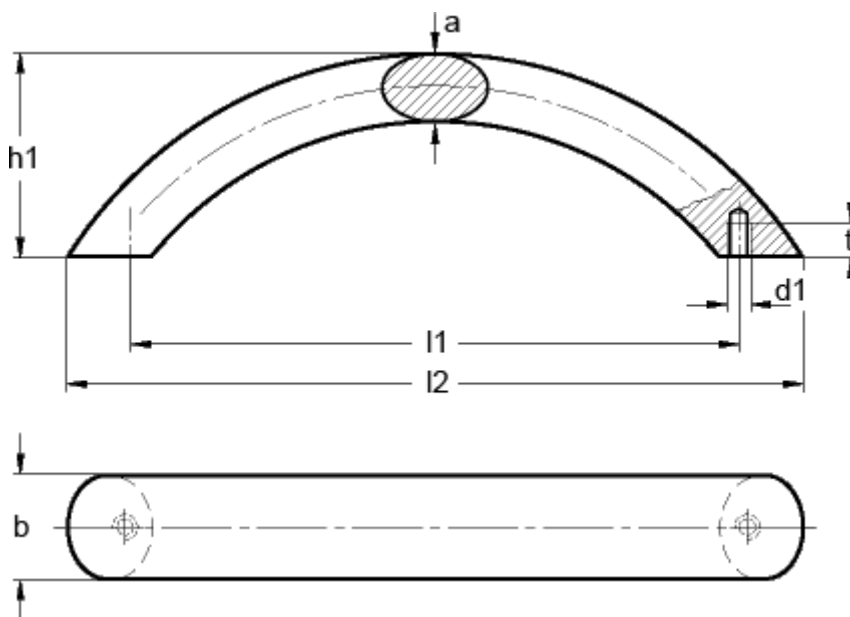

a	= 17
b	= 26
d1	= M8
h1	= 57
l1	= 192
l2	= 227
t min	= 12.0